

REVISIONS			
REV	DESCRIPTION	DATE	APPROVED
453-1	WT CWB WITH H.O.P.S	3/18/09	

453-1 WT CABINET WALL "B"
 F-SERIES CHASSIS
 H.O.P.S INSTALLED

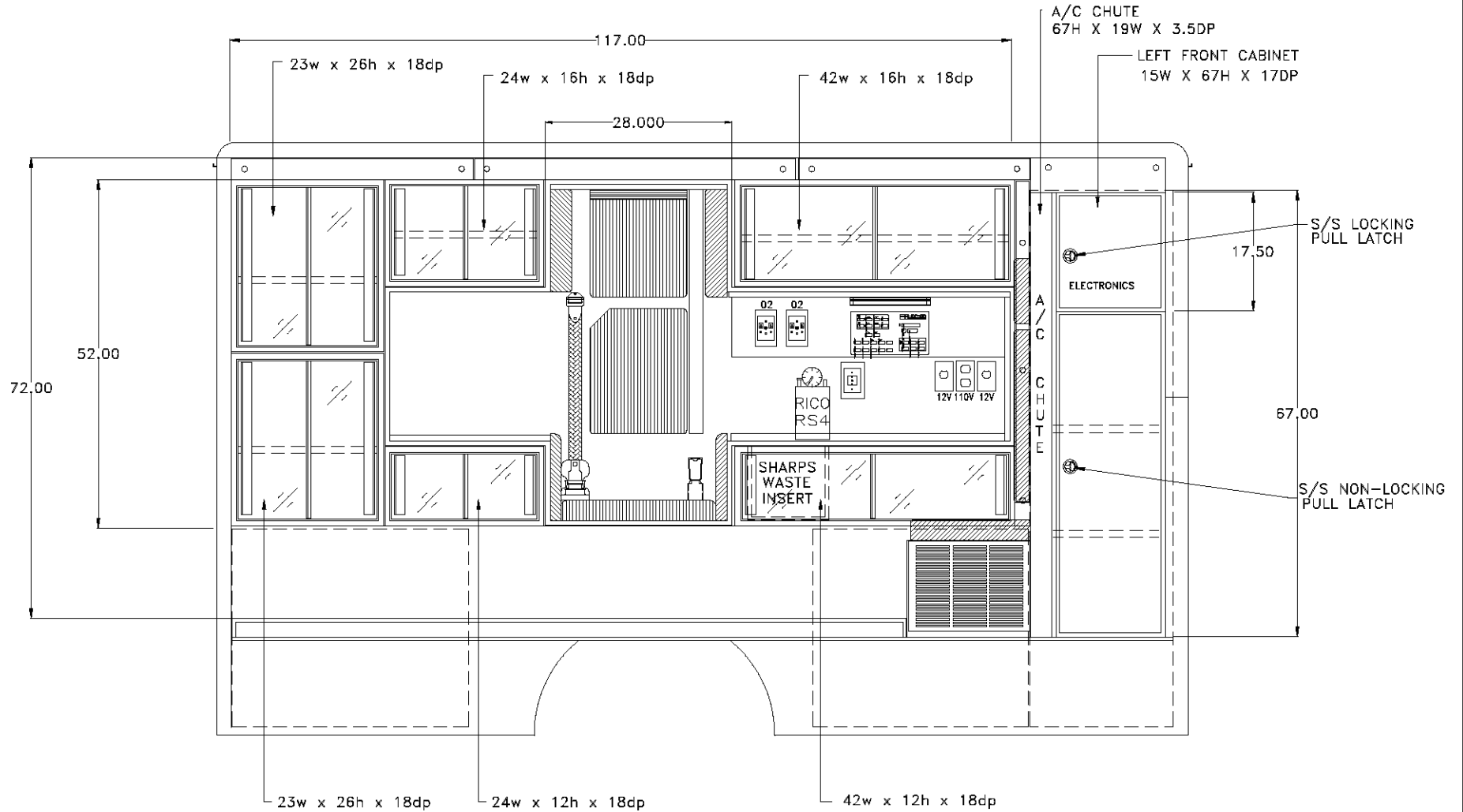

REVISIONS			
REV	DESCRIPTION	DATE	APPROVED
453-1	WT CWC WITH H.O.P.S	3/18/09	

453-1 WT CABINET WALL "C" F-SERIES CHASSIS H.O.P.S INSTALLED

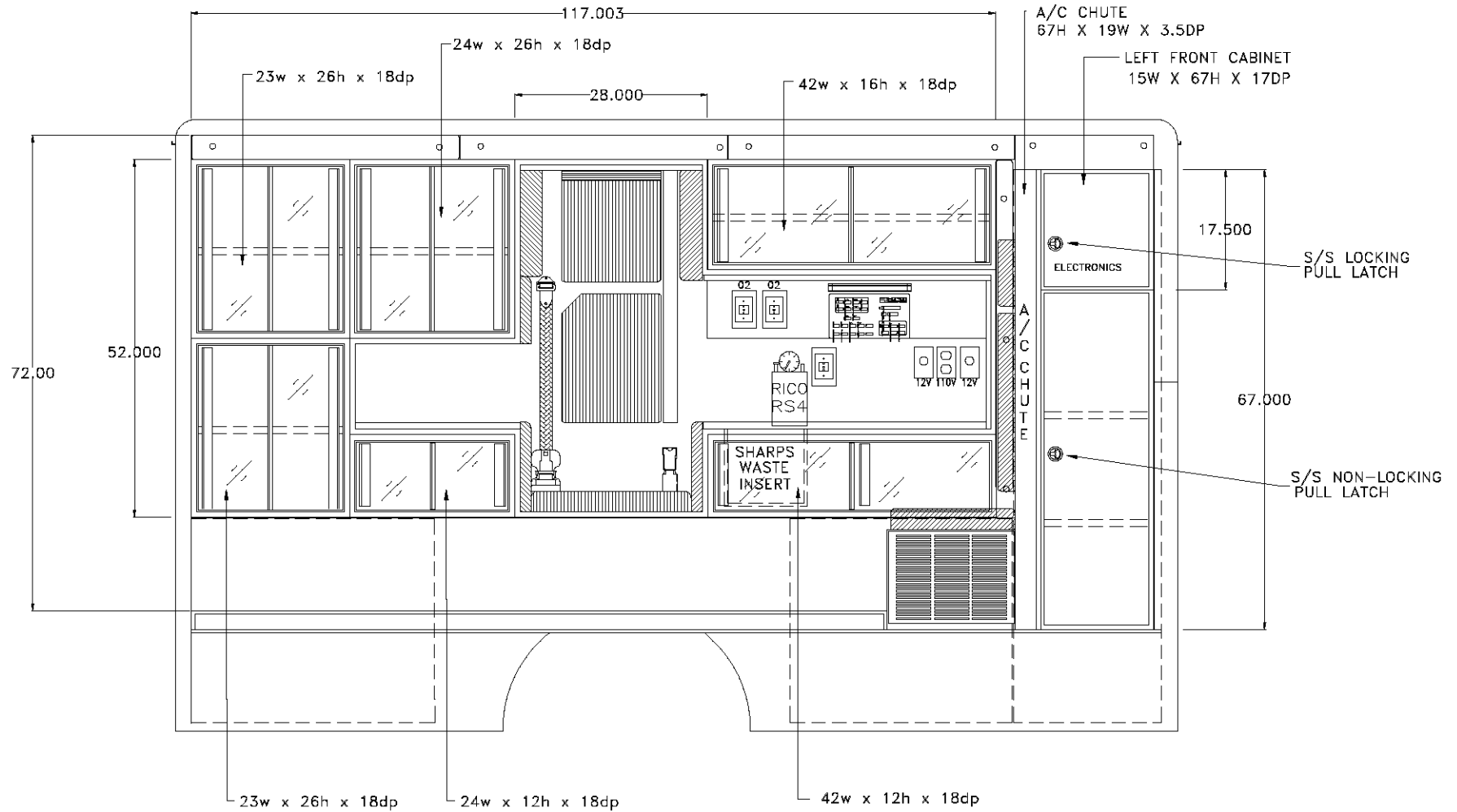

REVISIONS			
REV	DESCRIPTION	DATE	APPROVED
431-1	WT CWD WITH H.O.P.S	3/18/09	

453-1 WT CABINET WALL "D"
 F-SERIES CHASSIS
 H.O.P.S INSTALLED

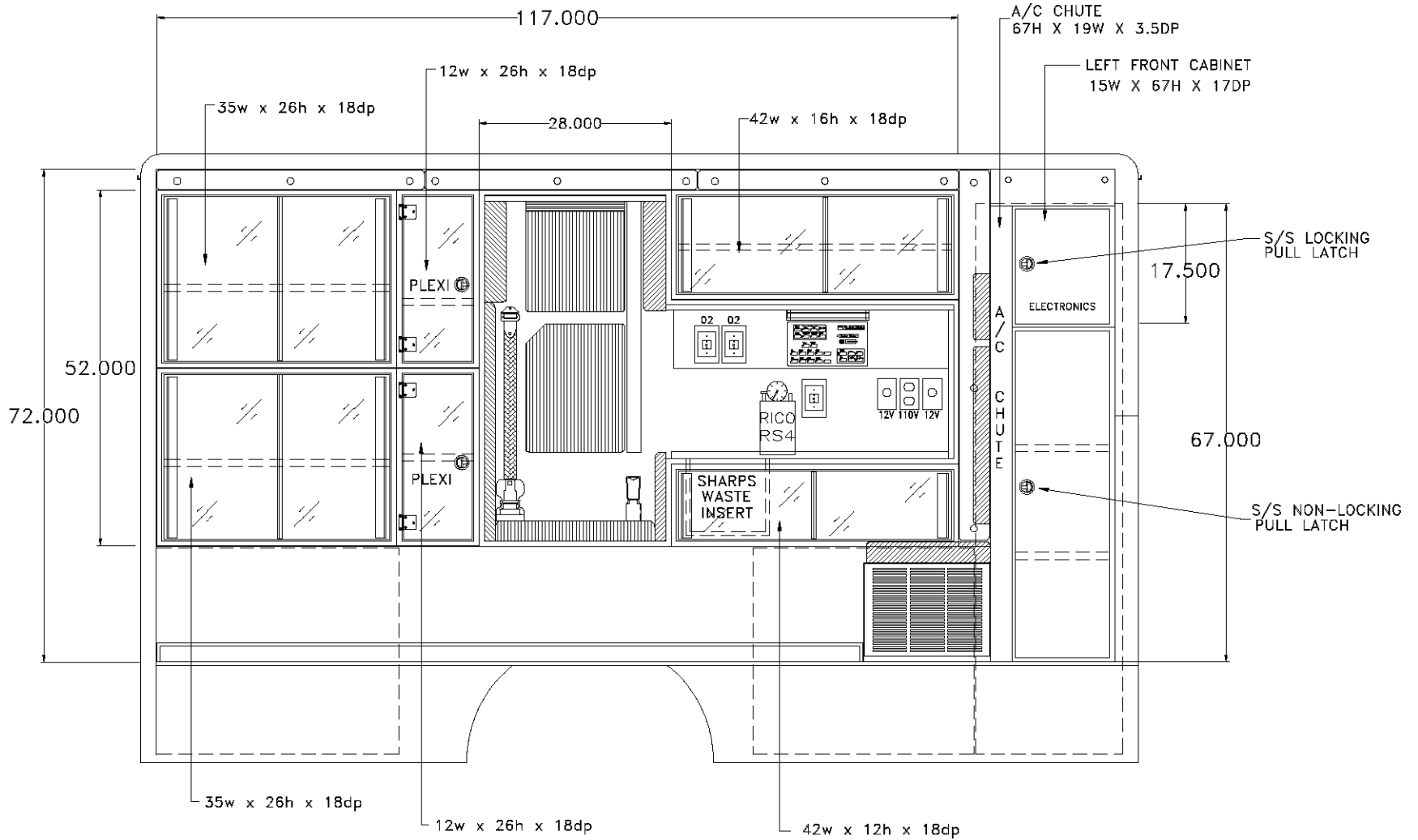

REVISIONS			
REV	DESCRIPTION	DATE	APPROVED
453-1	WT CWE WITH H.O.P.S	3/18/09	

453-1 WT CABINET WALL "E"
F-SERIES CHASSIS
H.O.P.S INSTALLED

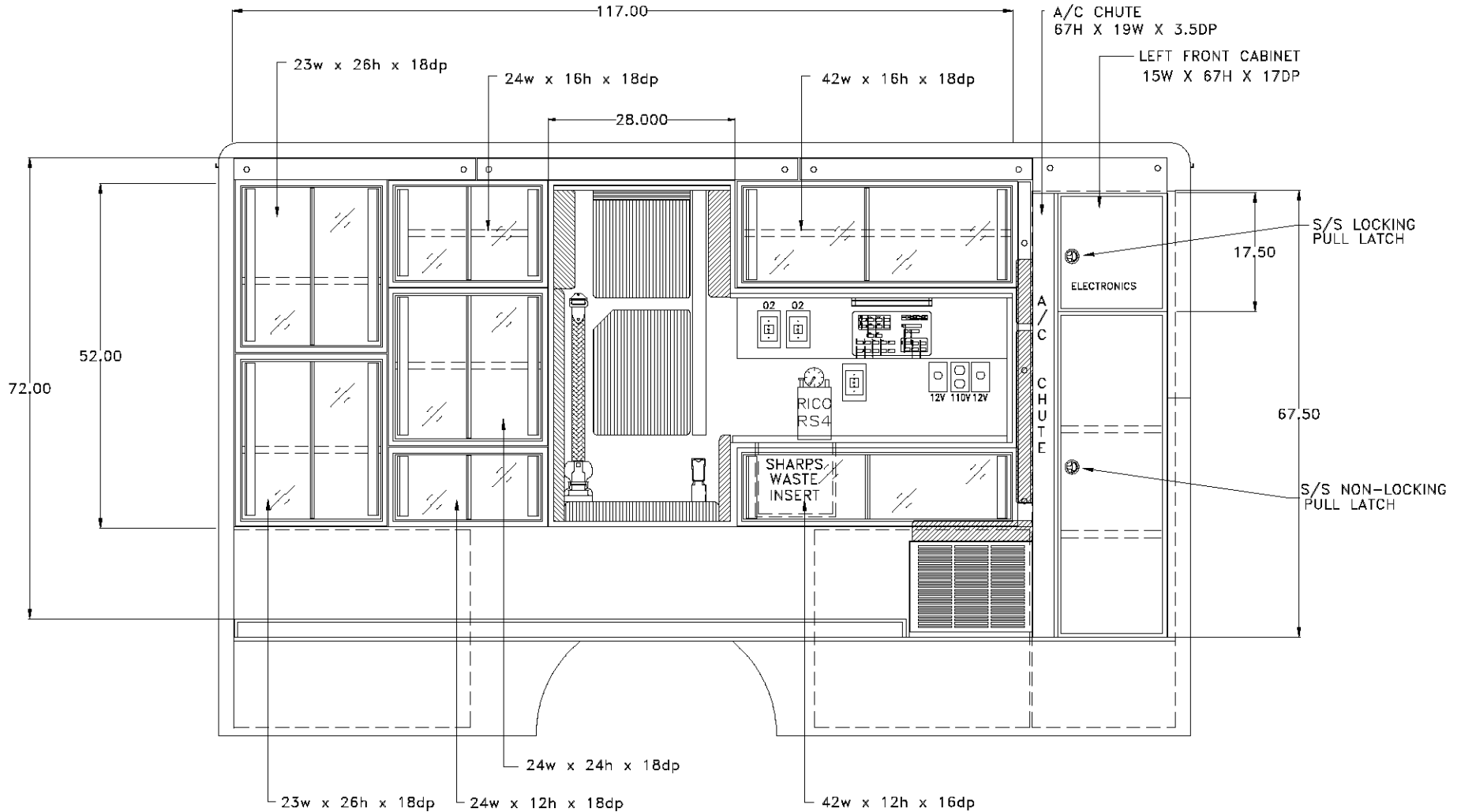

REVISIONS			
REV	DESCRIPTION	DATE	APPROVED
453-1	WT CNF WITH H.O.P.S	3/18/08	

453-1 WT CABINET WALL "F"
F-SERIES CHASSIS
H.O.P.S INSTALLED

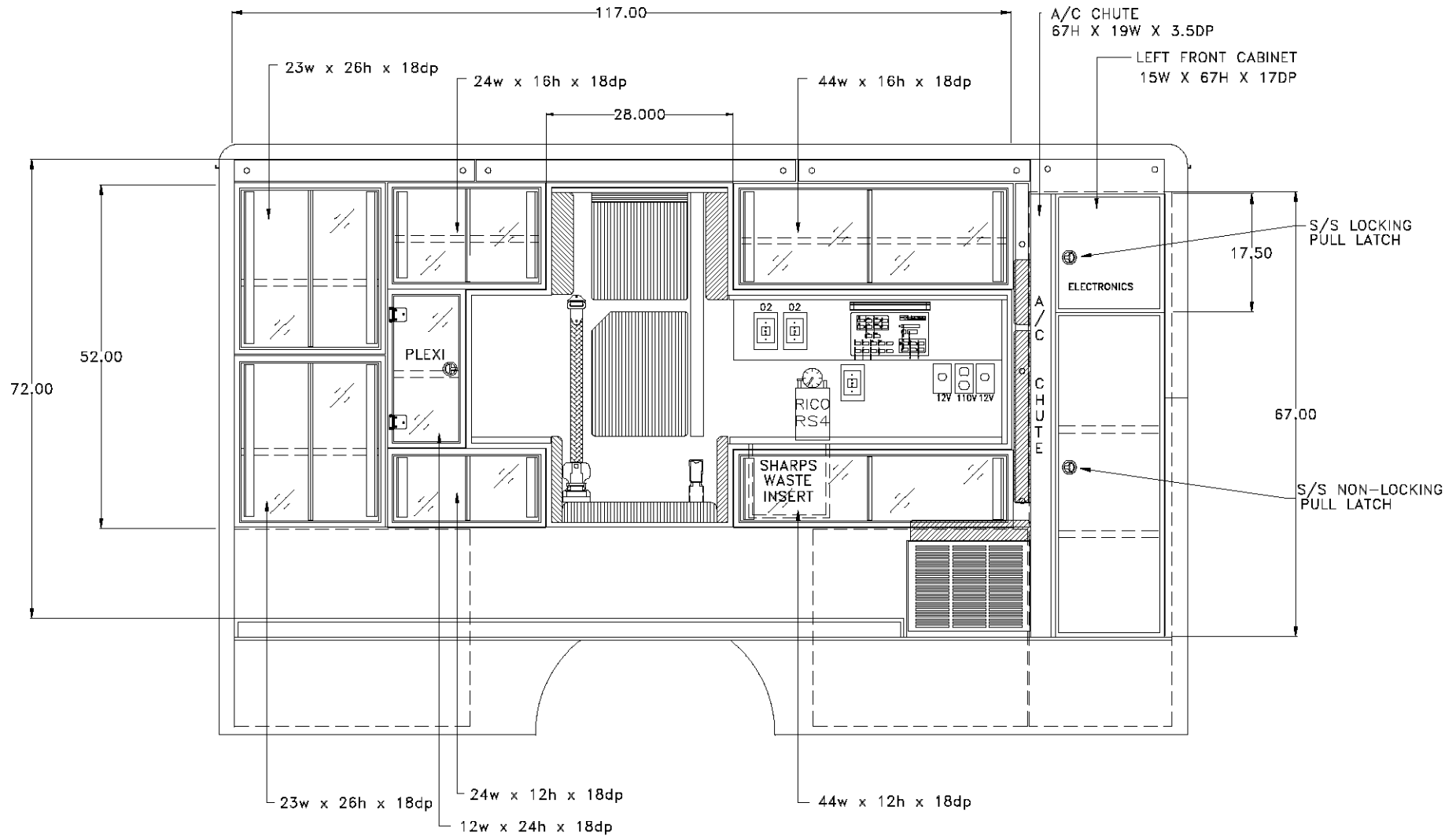

VEHICLE PRODUCTION NUMBER

XXXXX

REV
C

REVISIONS			
REV	DESCRIPTION	DATE	APPROVED
	453-1 WT EX	3/18/09	

453-1 WT EXTERIOR
F-SERIES CHASSIS

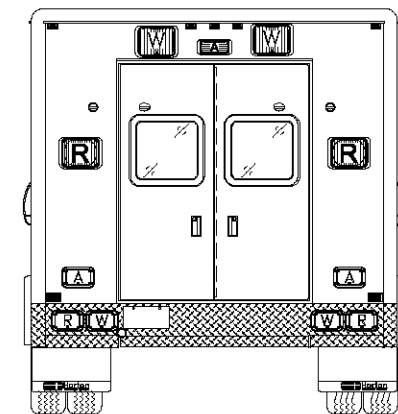
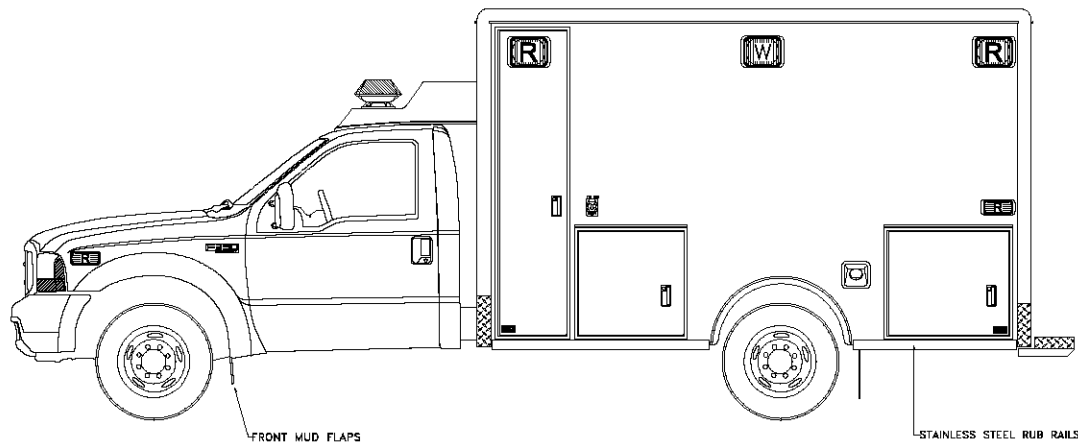
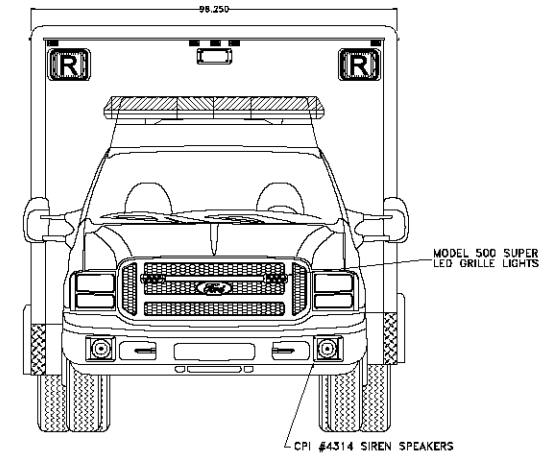
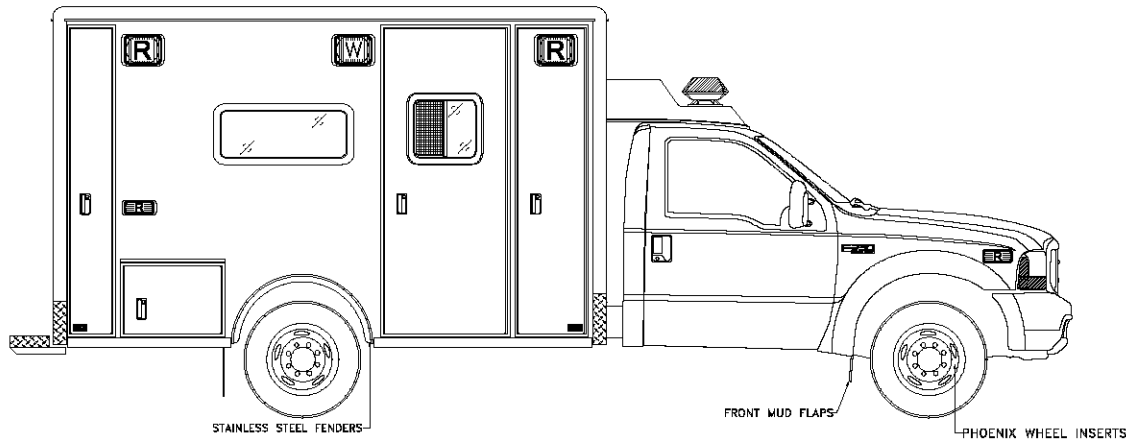

DRAWING DEPICTS LIGHTBAR OPTION

SPECIFICATION

DRAWING

REVISIONS			
REV	DESCRIPTION	DATE	APPROVED
	453-1 WT FW WITH H.D.P.S	3/18/09	

453-1 WT FRONT WALL
F-SERIES CHASSIS
H.O.P.S INSTALLED

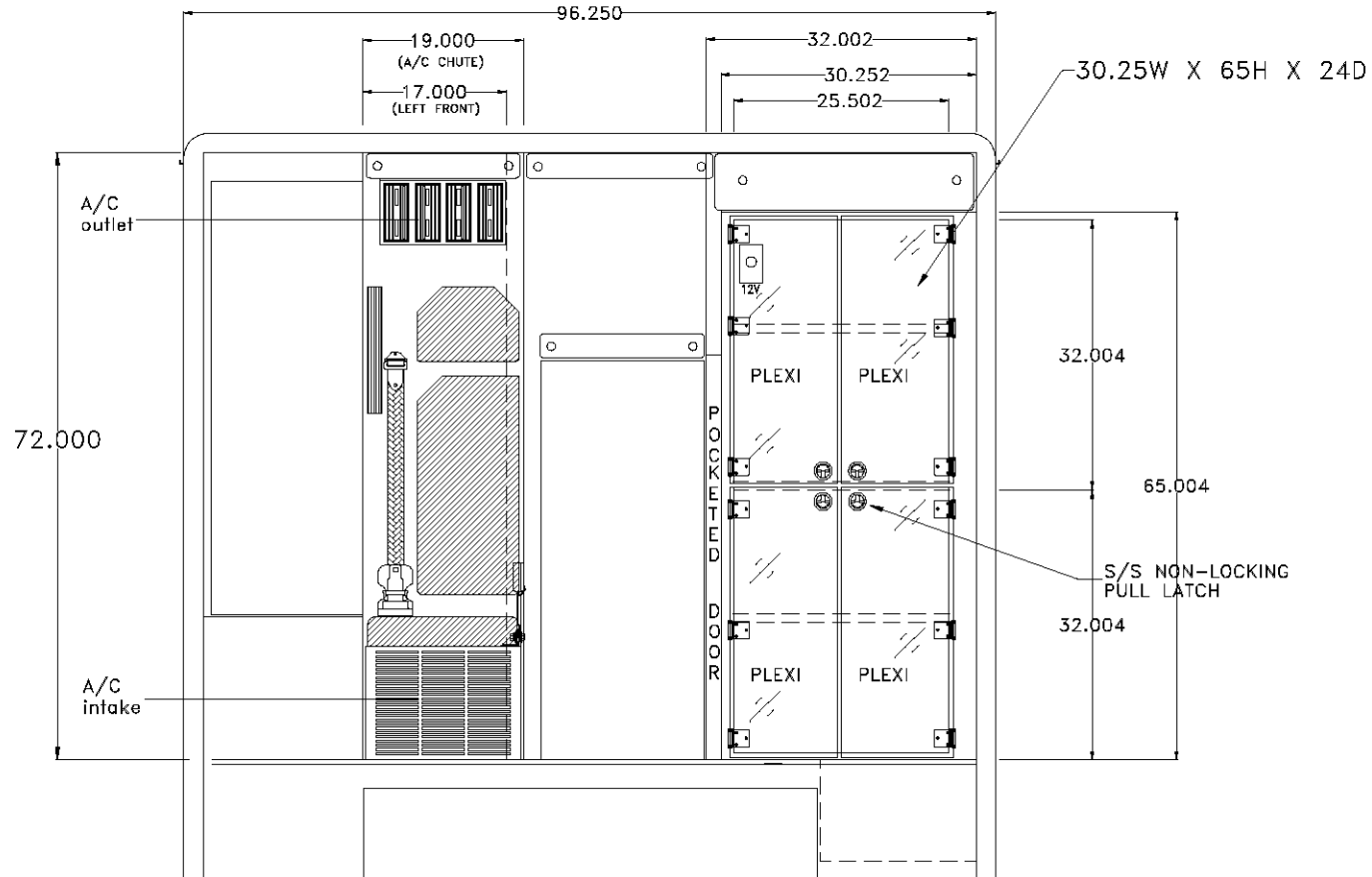

VEHICLE PRODUCTION NUMBER XXXXX

REV
C

REVISIONS			
REV	DESCRIPTION	DATE	APPROVED
	453-1 WT OHA	3/18/09	

453-1 WT OVERHEAD WITHOUT CPR SEAT

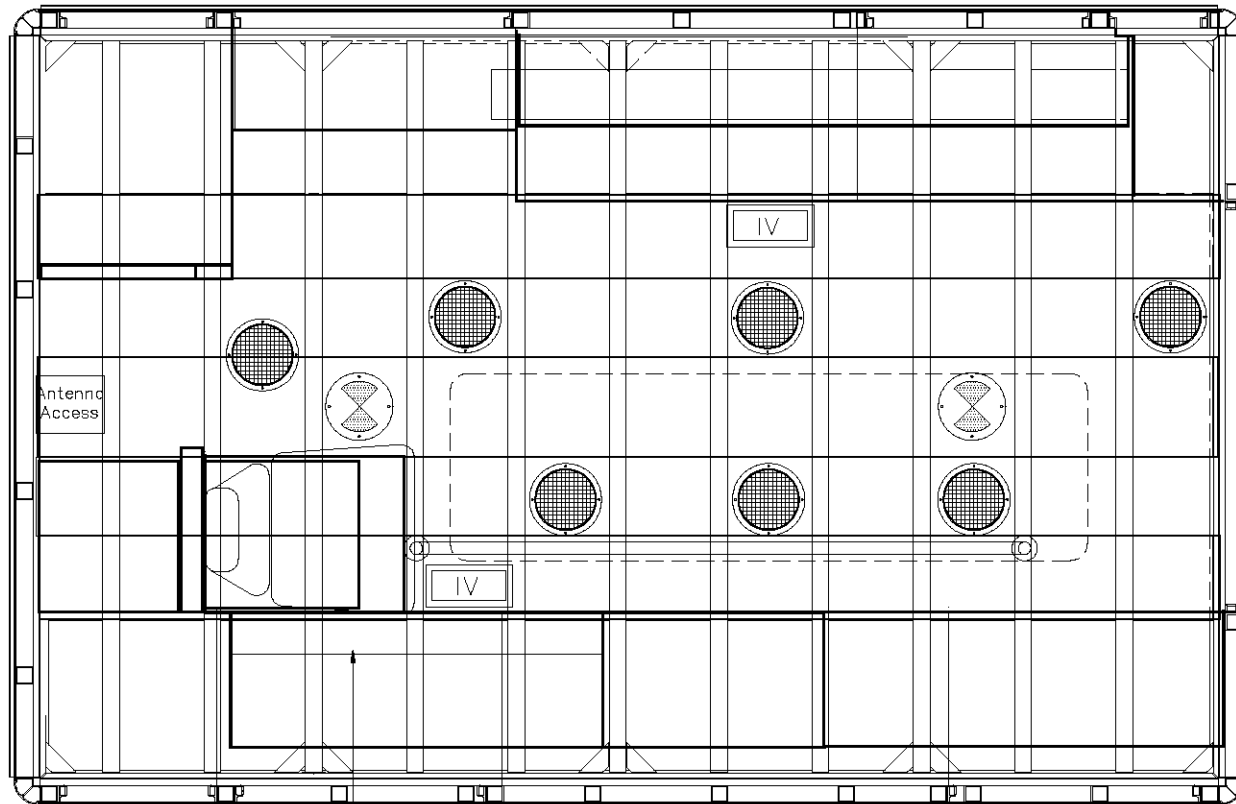

02 PANEL

SPECIFICATION

DRAWING

VEHICLE PRODUCTION NUMBER XXXXX

REV
C

REVISIONS			
REV	DESCRIPTION	DATE	APPROVED
	453-1 WT DHB	3/18/09	

453-1 WT OVERHEAD WITH CPR SEAT
F-SERIES CHASSIS

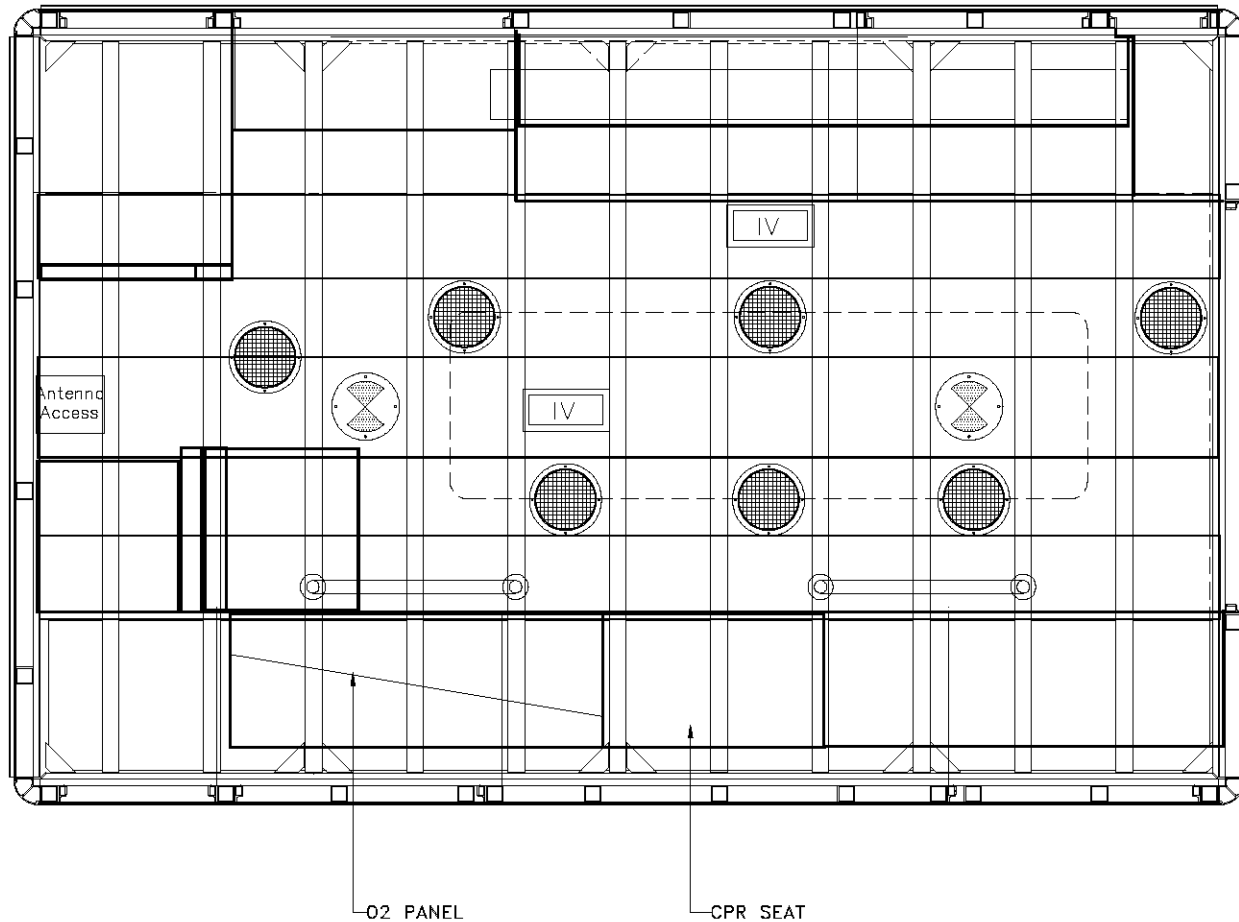

SPECIFICATION

DRAWING

VEHICLE PRODUCTION NUMBER

XXXXX

REV
C

REVISIONS			
REV	DESCRIPTION	DATE	APPROVED
	453-1 WT RW	3/18/09	

453-1 WT REAR WALL
F-SERIES CHASSIS

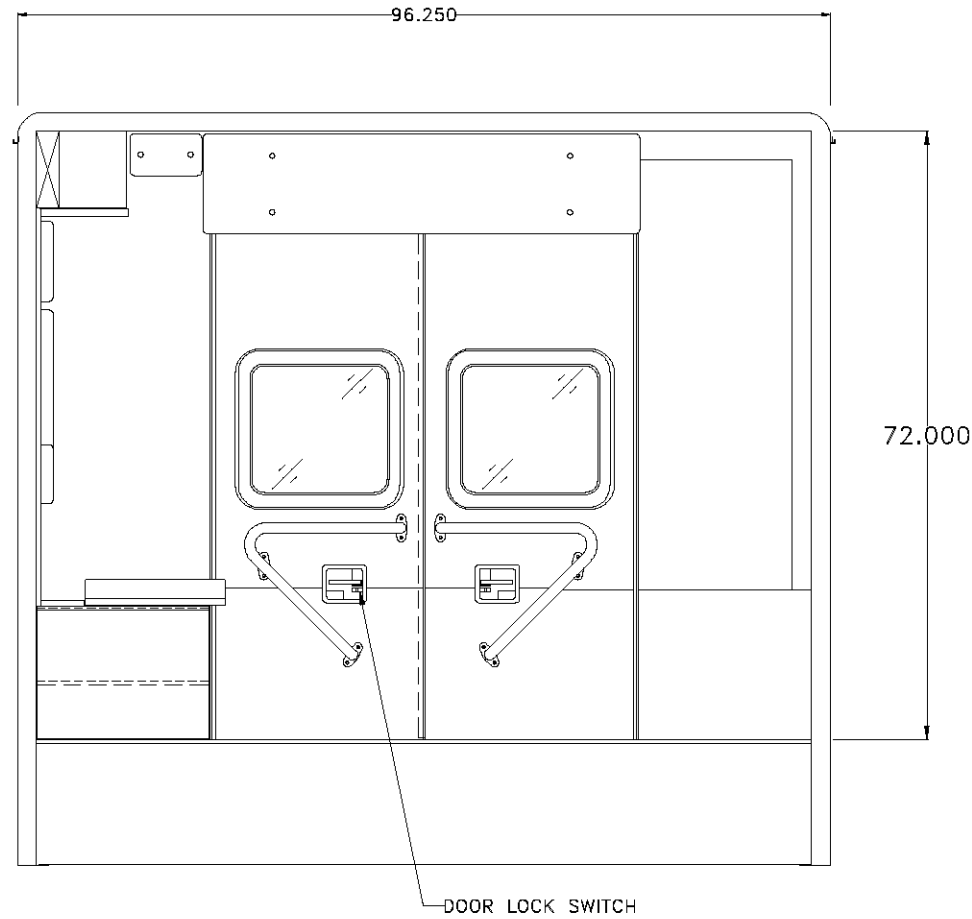

SPECIFICATION

DRAWING

VEHICLE PRODUCTION NUMBER XXXXX

REV
C

REVISIONS			
REV	DESCRIPTION	DATE	APPROVED
	453-1 WT SW WITH H.O.P.S	3/18/09	

453-1 WT SIDE WALL
F-SERIES CHASSIS
H.O.P.S INSTALLED

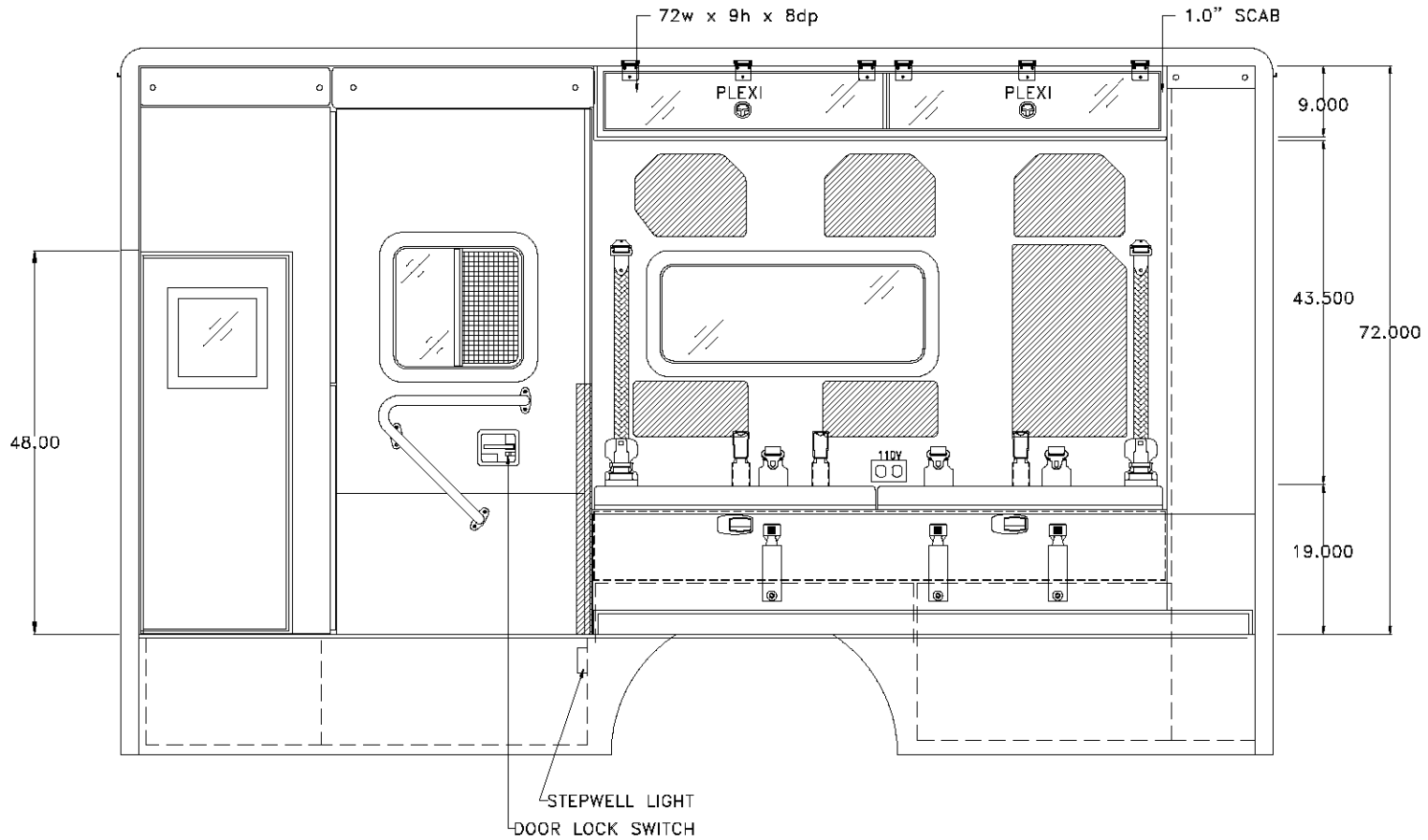

SPECIFICATION

DRAWING

VEHICLE PRODUCTION NUMBER XXXXX

REV
C

REVISIONS			
REV	DESCRIPTION	DATE	APPROVED
	453-1 WT CWA	3/18/09	

453-1 WT CABINET WALL "A"

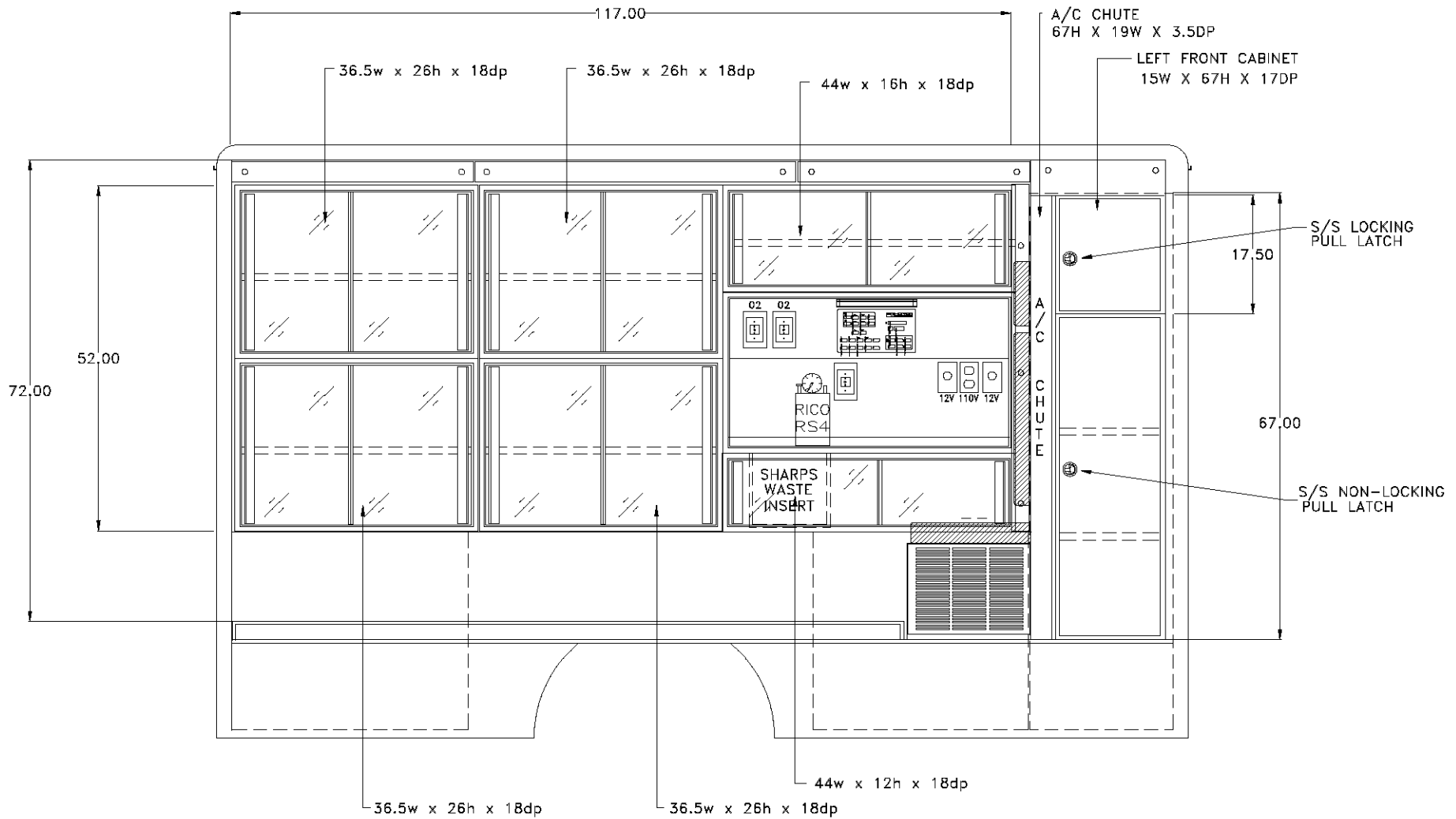

SPECIFICATION

DRAWING